

WPC Privacy Wall

Assembly Instructions

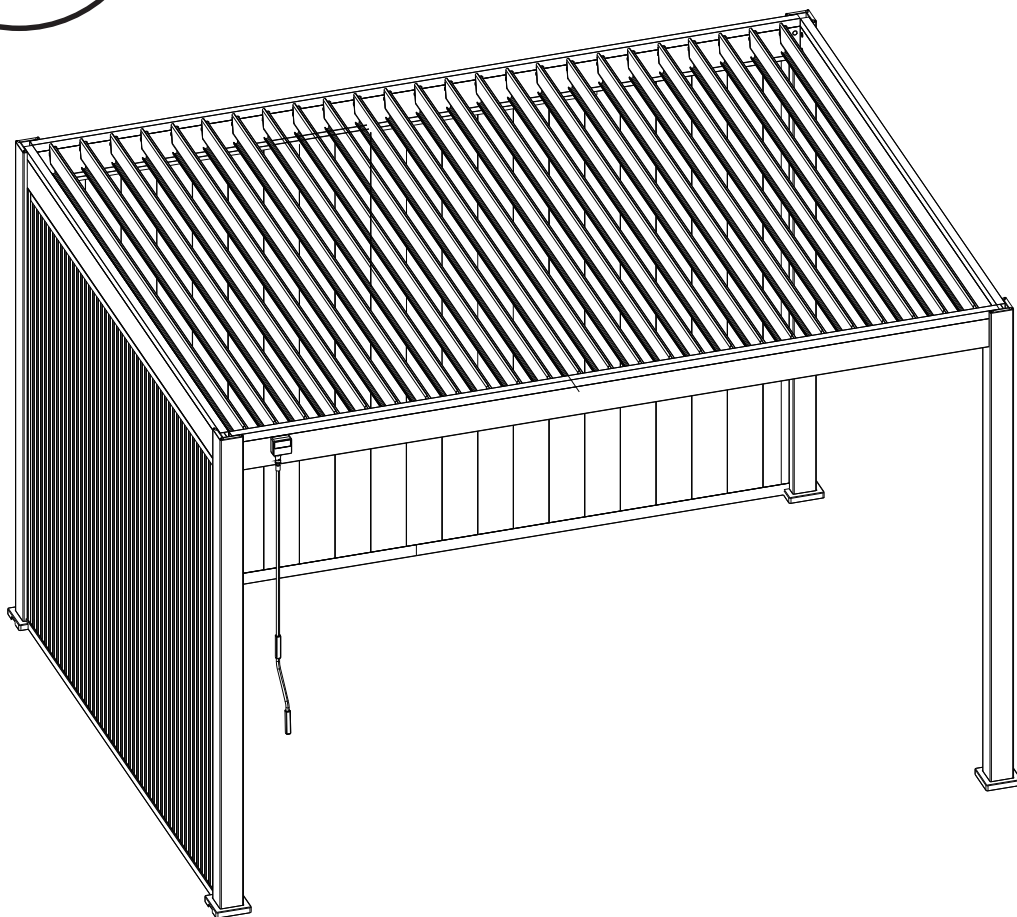

Paragon Group USA

Customer Service Contact Information: 1-877-782-4482

support@paragon-outdoor.com

©     @paragonoutdoorcompany

WPC Privacy Wall

Please read the following instructions completely before you begin assembly. Any errors made during installation are not covered by the product's warranty. If you have any questions during the installation process, please call us .

NECESSARY TOOLS AND SAFETY GEAR(NOT SUPPLIED)

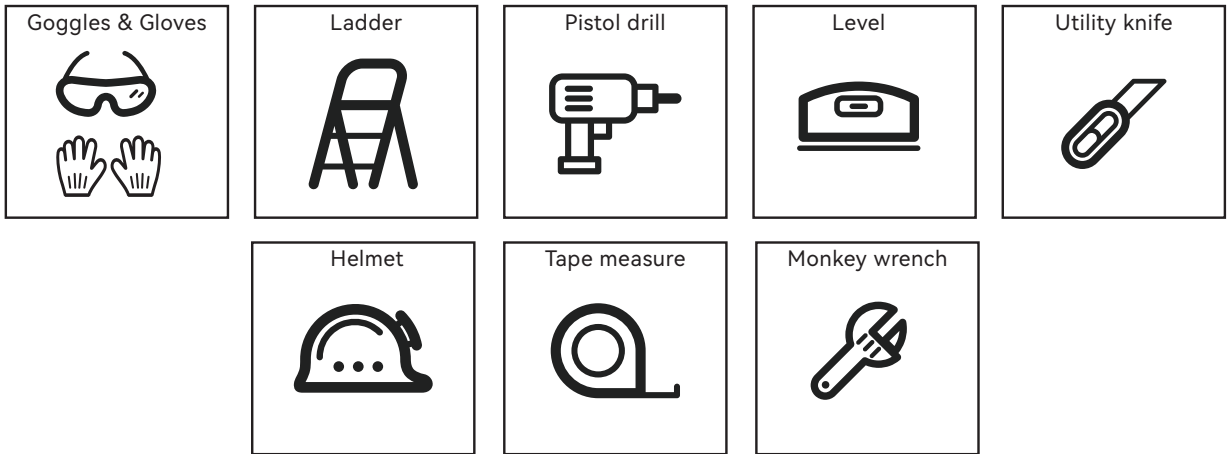

Paragon Outdoor's 3 Year Limited Warranty

Limited Warranty

Paragon Outdoor warrants to the original purchaser that all components and hardware in its products, under normal use and service conditions, will be free from defects in manufacturing and materials for a period of 3 years* from the date of original retail purchase subject to the definitions, terms and conditions contained in this warranty.

Paragon Outdoor will replace any defective part within the warranty period, at its discretion, if it is found to be defective of workmanship or materials. Paragon Outdoor may request photographs, videos, or physical return of the defective part for verification purposes.

Warranty Conditions

1. This warranty shall be valid only if the product is installed, cleaned, handled and maintained in accordance with Paragon Outdoor's written recommendations listed below.
2. Without derogating from the above, damage caused by use of force, incorrect handling, inappropriate use, neglectful use or assembly or maintenance, accidents, impact from foreign objects, vandalism, pollutants, alteration, painting, connecting, gluing, sealing not in accordance with the user's manual, or damage resulting from cleaning with incompatible detergents and minor deviations of the product are not covered by this warranty.
3. This warranty does not apply to damage resulting from "force majeure", which includes but is not limited to, hail, storm, tornado, hurricane, blizzard, flood, or fire effects, beyond stated claims.
4. This warranty is void if structural parts and components used are not compatible with Paragon Outdoor's written recommendations.
5. This warranty applies to the original owner and registrant and is non-transferable.

Operation: Privacy Panels

1. These are four-season products, meaning that they may be left up year-round.
2. Check all hardware for tightness before and during usage of the unit. Tighten screws at least twice a year.

Defective & Replacement Parts

1. In case of a defective part or if a problem occurs while using this product, please contact Paragon Outdoor Customer Service at (877) 782-4482.
2. To order replacement parts, identify the model number and the part number found in your assembly manual and contact Paragon Outdoor customer service.

Care and Cleaning

Use a mild soap and wash with warm water using a sponge or fabric cloth. Rinse with clean water.

Planning Assembly

1. It is the consumer's responsibility to comply with building rules, regulations, zoning restrictions or any other regional restrictions and obtain the required permits before purchasing the product and installing it.
2. Make sure that every part is in the box before beginning installation.
3. Some parts may have sharp edges; it is recommended to wear gloves, protective eyewear and closed shoes.
4. You must schedule enough time to complete assembly as you cannot leave the product unattended if it is not fully assembled, even if bolted to the ground.
5. A minimum of 3 people are required for a safe assembly of the product. This will vary depending on certain steps of installation.
6. Follow each instruction manual carefully to ensure the strength of the product.
7. To avoid damage to the product and its part, use the proper tools. Do not use the product as a support. The use of a ladder may be necessary at certain stages of assembly.
8. Keep the instruction manual and the parts list in case of future needs or references.
9. Do not assemble the product on days of wind or rain.

Safety Information

IT IS VERY IMPORTANT TO READ AND FOLLOW ALL SAFETY PRECAUTIONS BEFORE ASSEMBLY AND DURING USE OF THE PRODUCT.

1. Keep children and pets away from assembly area.
2. When assembling and using the product, basic safety precautions must always be followed to reduce risks of personal injuries and damages to the product and its surroundings.
3. Ensure that all parts are in the boxes before starting the assembly. It is recommended to wear protective gloves since some of the parts have sharp edges.
4. Begin the assembly and install the product more than 10 ft. away from any obstructions including, but not limited to, a fence, overhanging branches, a laundry line or electrical wire and as much as possible in a place protected from the wind.
5. Always install the product on a level platform and be anchored according to the surface recommendations in the assembly instructions.
6. Check all hardware for tightness before and during the use of the product. Tighten screws at least twice a year.
7. Do not install the product in a space where there is a possibility of high winds.

Customer Service Contact

If you are experiencing any issues with the assembly of your new structure, please do not return – our expert customer service team will help you with all questions for a smooth assembly process.

Email: support@paragon-outdoor.com











Call: +1 (877) 782-4482





Hours of Operation



Speak with an Expert Customer Service Agent: Monday – Friday: 8:00 am – 5:00 pm CST
We are available 24 hours a day, 7 days a week. Please allow up to 24 hours for a response.

Accessory List-10'

1/3

| REF | PICTURE | | QTY |
|-----|---|---|-----|
| K1 |  |  1.3"x1.6"-5'5" 32X40-2701mm | 1 |
| K2 |  |  1.3"x1.6"x7'7" 32X40-2323mm | 1 |
| K3 |  |  1.6"x2"x9'2" 40X60-2790mm | 1 |
| K6 |  |  1.4"x2"x7'7" 34X50-2323mm | 1 |
| K7 |  |  0.23"x2"x7'7" 6X50-2323mm | 1 |



| REF | PICTURE | | QTY |
|-----|---|--|-----|
| L1 |  |  7.4"x1.1"x7'7" 188X28-2316mm | 3 |
| L2 |  |  4"x1.1"x7'7" 100X28-2316mm | 1 |

| REF | PICTURE | QTY |
|-----|--|-----|
| S5 |  4x16 | 16 |
| S8 |  8x100 | 4 |



| REF | PICTURE | QTY |
|-----|---|-----|
| Z5 |  PH2 | 1 |

Accessory List-10'

2/3

| REF | PICTURE | | QTY |
|-----|---|---|-----|
| L1 |  |  <p data-bbox="1016 401 1146 442">7.4"x1.1"x77" 188X28-2316mm</p> | 6 |

3/3





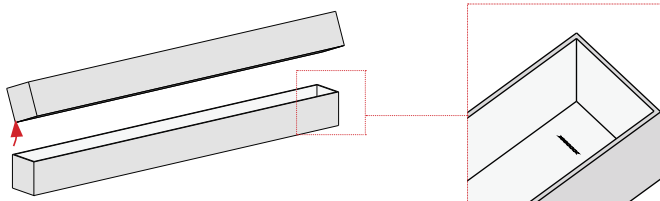







| REF | PICTURE | | QTY |
|-----|---|---|-----|
| L1 |  |  <p data-bbox="1016 680 1146 720">7.4"x1.1"x77" 188X28-2316mm</p> | 6 |



There is a Product Tracking Number in the inner side of the carton(see below diagram). For better and efficient after-sales in the future, when tear down the carton box, please take a photo of the Tracking Number and save the photo.



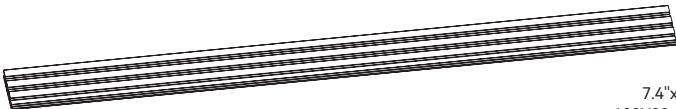

Accessory List-12'

1/4

| REF | PICTURE | | QTY |
|-----|---|--|-----|
| K1 |  |  1.3"x1.6"-5'5" 32X40-1655mm | 2 |
| K2 |  |  1.3"x1.6"x7'7" 32X40-2323mm | 1 |
| K4 |  |  1.6"x2"x5'7" 40X60-1700mm | 1 |
| K5 |  |  1.6"x2"x5'7" 40X60-1700mm | 1 |
| K6 |  |  1.4"x2"x7'7" 34X50-2323mm | 1 |
| K7 |  |  0.23"x2"x7'7" 6X50-2323mm | 1 |



| REF | PICTURE | | QTY |
|-----|---|---|-----|
| L1 |  |  7.4"x1.1"x7'7" 188X28-2316mm | 1 |
| L2 |  |  6.8"x1.1"x7'7" 175X28-2316mm | 1 |

| REF | PICTURE | QTY |
|-----|--|-----|
| S5 |  4x16 | 20 |
| S8 |  8x100 | 6 |

| REF | PICTURE | QTY |
|-----|---|-----|
| Z5 |  PH2 | 1 |

Accessory List-12'

2/4

| REF | PICTURE | | QTY |
|-----|---|---|-----|
| L1 |  |  7.4"x1.1"x7'7" 188X28-2316mm | 5 |

3/4

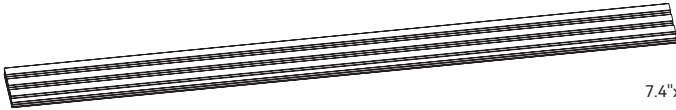
| REF | PICTURE | | QTY |
|-----|---|---|-----|
| L1 |  |  7.4"x1.1"x7'7" 188X28-2316mm | 6 |

4/4

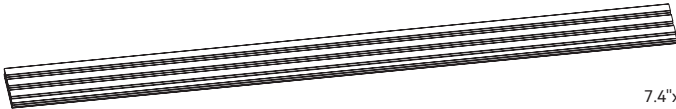



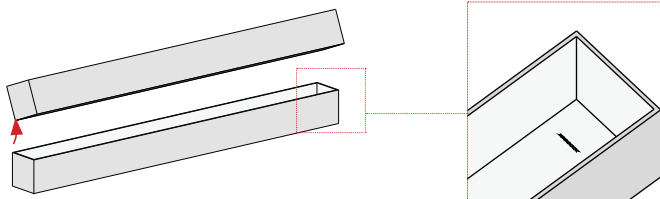







| REF | PICTURE | | QTY |
|-----|---|---|-----|
| L1 |  |  7.4"x1.1"x7'7" 188X28-2316mm | 6 |



There is a Product Tracking Number in the inner side of the carton(see below diagram). For better and efficient after-sales in the future, when tear down the carton box, please take a photo of the Tracking Number and save the photo.



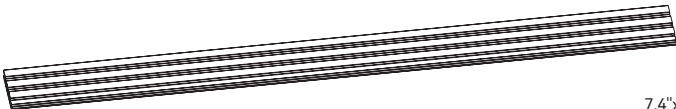

Accessory List-14'

1/4

| REF | PICTURE | | QTY |
|-----|---|--|-----|
| K1 |  |  1.3"x1.6"x6'6" 32X40-1969mm | 2 |
| K2 |  |  1.3"x1.6"x7'7" 32X40-2323mm | 1 |
| K4 |  |  1.6"x2"x6'7" 40X60-2014mm | 1 |
| K5 |  |  1.6"x2"x6'7" 40X60-2014mm | 1 |
| K6 |  |  1.4"x2"x7'7" 34X50-2323mm | 1 |
| K7 |  |  0.23"x2"x7'7" 6X50-2323mm | 1 |



| REF | PICTURE | | QTY |
|-----|---|--|-----|
| L1 |  |  7.4"x1.1"x7'7" 188X28-2316mm | 4 |
| L2 |  |  4"x1"x7'7" 99X28-2316mm | 1 |

| REF | PICTURE | QTY |
|-----|--|-----|
| S5 |  4x16 | 20 |
| S8 |  8x100 | 6 |

| REF | PICTURE | QTY |
|-----|---|-----|
| Z5 |  PH2 | 1 |

Accessory List-14'

2/4

| REF | PICTURE | | QTY |
|-----|---|--|-----|
| L1 |  |  | 6 |

3/4

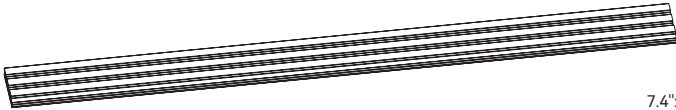
| REF | PICTURE | | QTY |
|-----|---|--|-----|
| L1 |  |  | 6 |

4/4

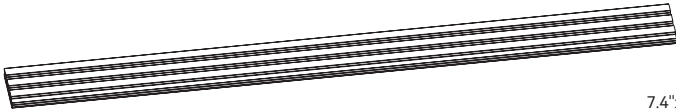
| REF | PICTURE | | QTY |
|-----|---|--|-----|
| L1 |  |  | 6 |

There is a Product Tracking Number in the inner side of the carton(see below diagram). For better and efficient after-sales in the future, when tear down the carton box, please take a photo of the Tracking Number and save the photo.

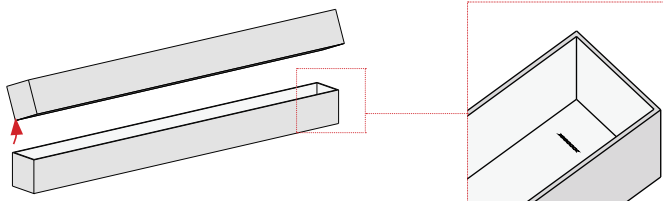

Installation

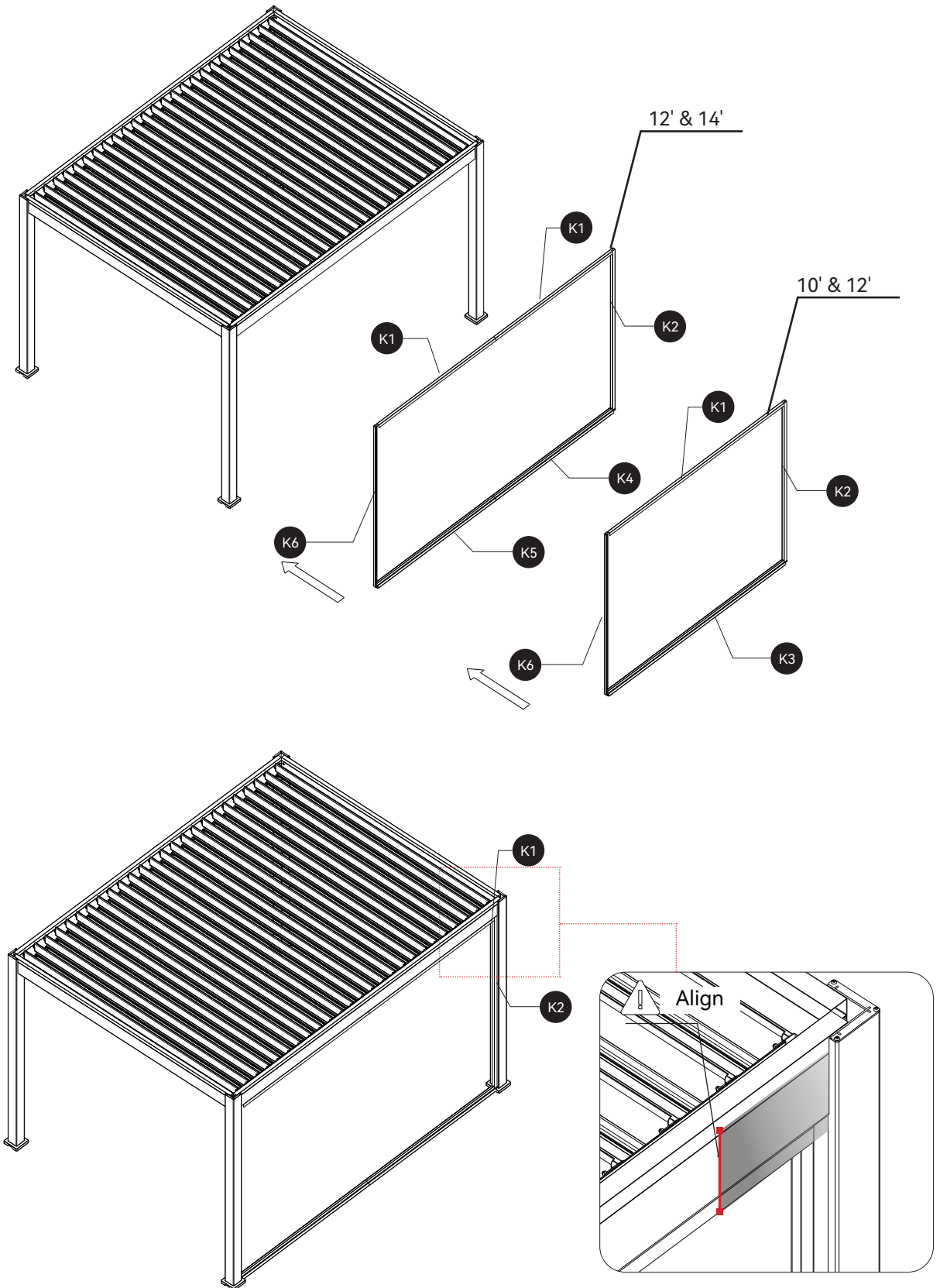

Installation

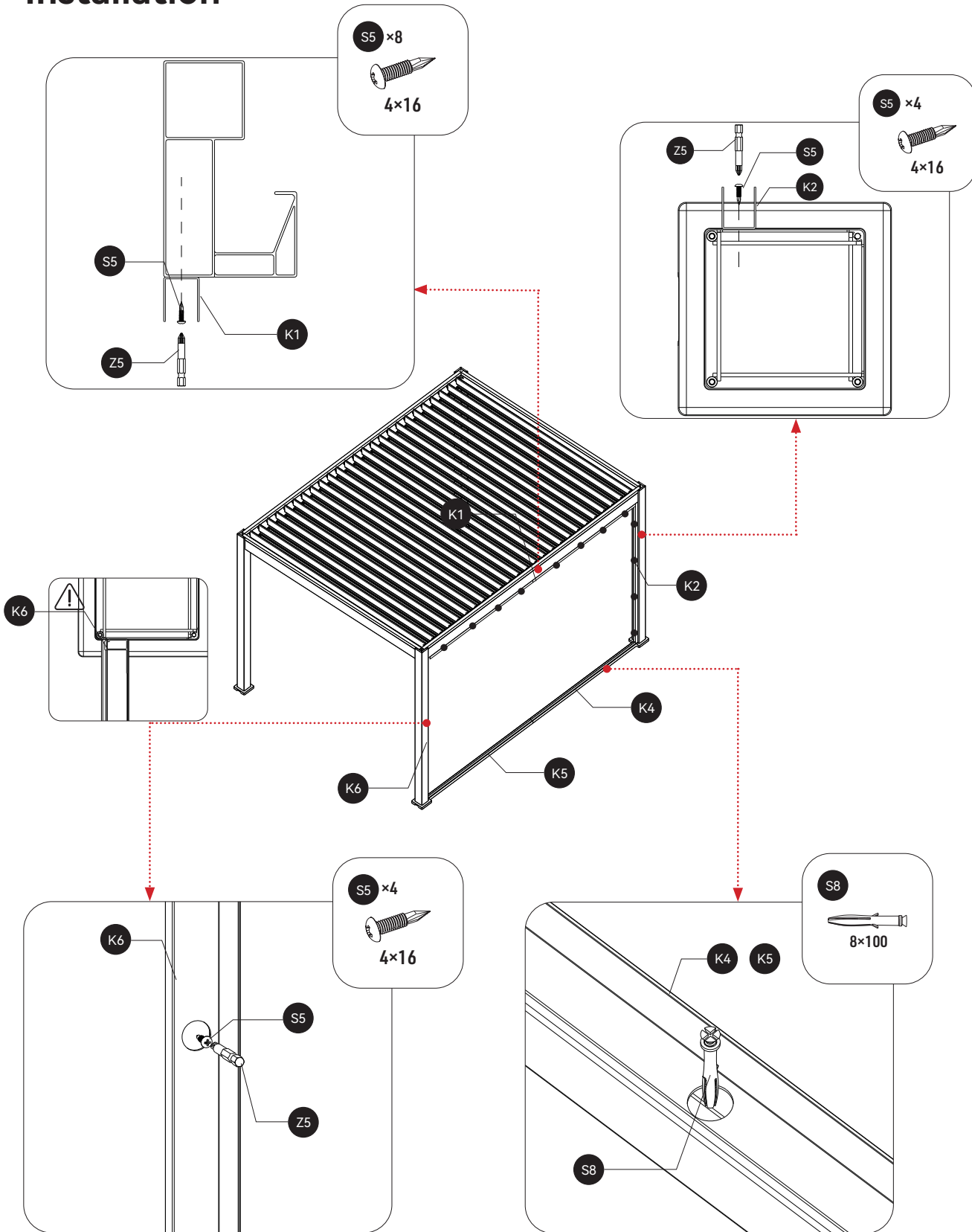

Installation

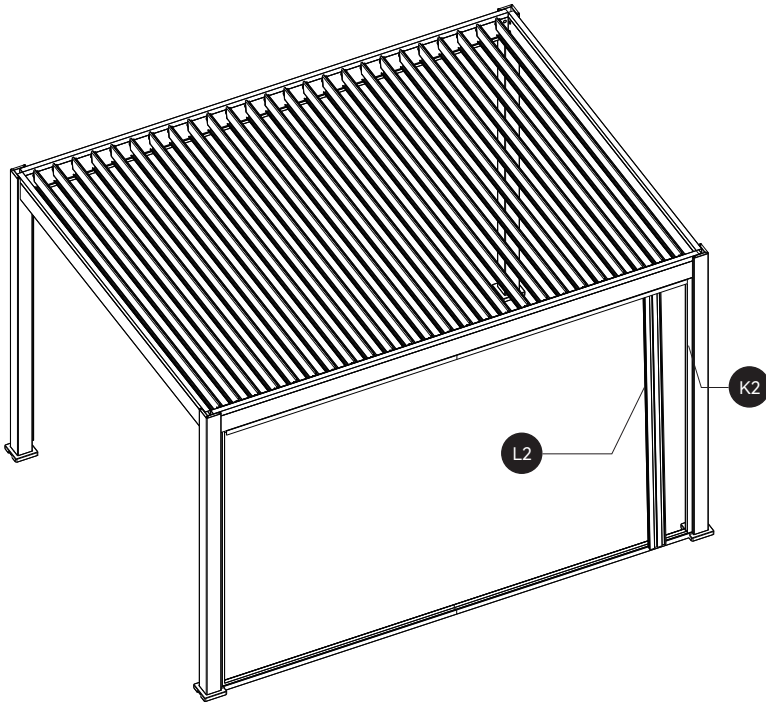

10' & 12'

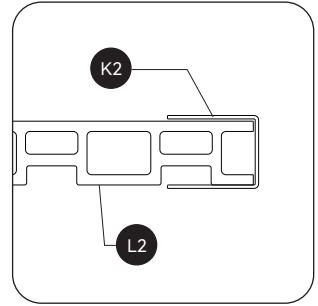

14'

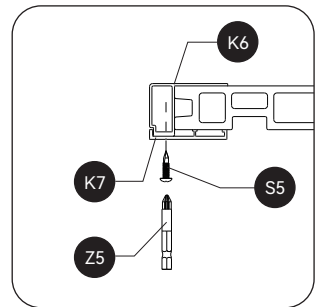
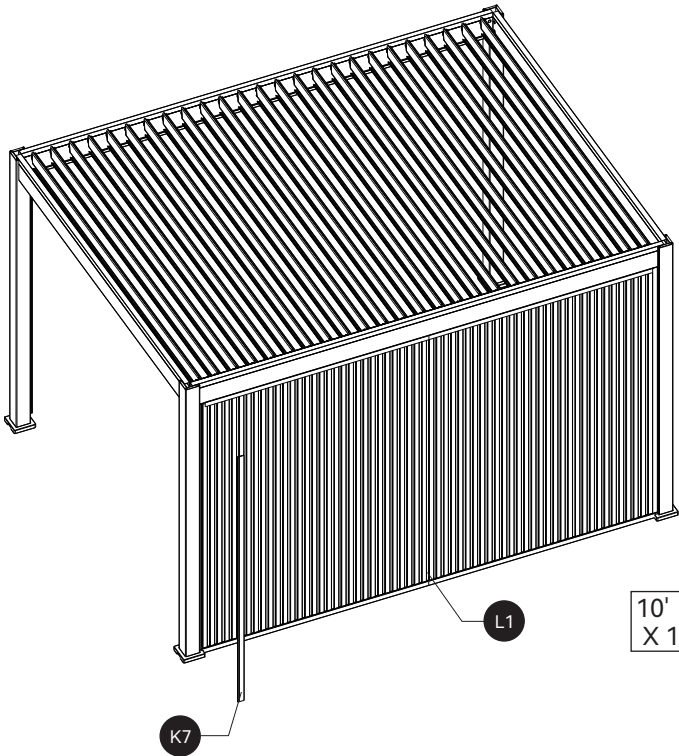
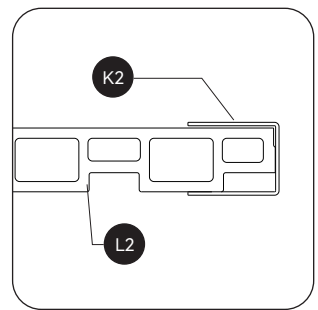

| | | |
|-------------|-------------|-------------|
| 10' X 15 | 12' X 18 | 14' X 20 |
|-------------|-------------|-------------|



Paragon Group USA

Customer Service Contact Information: 1-877-782-4482
support@paragon-outdoor.com

 @paragonoutdoorcompany